



US007473550B2

(12) **United States Patent**
Vodyanoy et al.

(10) **Patent No.:** **US 7,473,550 B2**
(45) **Date of Patent:** **Jan. 6, 2009**

(54) **USE OF ACACIA GUM TO ISOLATE AND PRESERVE A BIOLOGICAL RECEPTOR ON A BIOSENSOR**

(75) Inventors: **Vitaly J. Vodyanoy**, Auburn, AL (US);
James M. Barbaree, Dadeville, AL (US);
Bryan A. Chin, Auburn, AL (US);
William Charles Neely, Auburn, AL (US);
Suram T. Pathirana, Sunnyvale, CA (US);
Timothy D. Braden, Auburn, AL (US)

(73) Assignee: **Auburn University**, Auburn, AL (US)

(*) Notice: Subject to any disclaimer, the term of this patent is extended or adjusted under 35 U.S.C. 154(b) by 337 days.

(21) Appl. No.: **11/073,963**

(22) Filed: **Mar. 7, 2005**

(65) **Prior Publication Data**

US 2005/0148019 A1 Jul. 7, 2005

Related U.S. Application Data

(62) Division of application No. 10/000,727, filed on Nov. 30, 2001, now Pat. No. 7,022,514.

(60) Provisional application No. 60/250,798, filed on Dec. 1, 2000, provisional application No. 60/250,799, filed on Dec. 1, 2000.

(51) **Int. Cl.**

C12M 1/34 (2006.01)
C12Q 1/68 (2006.01)
G01N 33/53 (2006.01)

(52) **U.S. Cl.** **435/287.2**; 435/6; 435/7.1

(58) **Field of Classification Search** 435/6, 435/7.1, 287.2

See application file for complete search history.

(56) **References Cited**

U.S. PATENT DOCUMENTS

3,235,337 A 2/1966 Artis
3,252,762 A 5/1966 Adams, Jr. et al.
3,645,852 A 2/1972 Axén et al.
4,021,368 A 5/1977 Nemeč et al.
4,115,534 A 9/1978 Ithakissios
4,284,553 A 8/1981 Brown et al.
4,329,337 A 5/1982 Sexton
4,391,909 A 7/1983 Lim
4,416,813 A 11/1983 Ikeda et al.
4,504,582 A 3/1985 Swann
4,588,584 A 5/1986 Lumsden et al.
4,610,962 A 9/1986 Takagi et al.
4,632,904 A 12/1986 Lee
4,659,664 A 4/1987 de Buda
4,673,566 A 6/1987 Goosen et al.
4,708,932 A 11/1987 Axén et al.
4,933,284 A 6/1990 Lapins et al.
4,959,305 A 9/1990 Woodrum
4,971,783 A 11/1990 Bolton et al.
4,975,224 A 12/1990 Pringle

5,034,428 A 7/1991 Hoffman et al.
5,096,481 A 3/1992 Sylvia et al.
5,116,747 A 5/1992 Moo-Young et al.
5,144,008 A 9/1992 Ikeda et al.
5,227,298 A 7/1993 Weber et al.
5,268,286 A 12/1993 Kobayashi et al.
5,318,382 A 6/1994 Cahill
5,427,935 A 6/1995 Wang et al.
5,474,890 A 12/1995 Di Virgilio et al.
5,550,178 A 8/1996 Desai et al.
5,554,386 A 9/1996 Groman et al.
5,627,063 A 5/1997 Divies et al.
5,648,091 A 7/1997 Sarama et al.
5,707,443 A 1/1998 Brown et al.
5,714,340 A 2/1998 Sutton et al.
5,728,350 A 3/1998 Kinoshita et al.
5,770,370 A 6/1998 Kumar
5,795,570 A 8/1998 Weber et al.
5,827,707 A 10/1998 Lamberti
5,849,274 A 12/1998 Gers-Barlag et al.
5,866,356 A 2/1999 Albert et al.
5,916,029 A 6/1999 Smith et al.

(Continued)

FOREIGN PATENT DOCUMENTS

DE 3733551 A1 4/1989

(Continued)

OTHER PUBLICATIONS

L. Tescione and Andrew Gregor. An Introductory Tutorial on Biosensor Technology Dec. 1990 & Dec. 10, 1991.*

(Continued)

Primary Examiner—Jon P Weber
Assistant Examiner—Kailash C Srivastava
(74) *Attorney, Agent, or Firm*—Andrus, Scales, Starke & Sawall, LLP

(57) **ABSTRACT**

Compositions and methods for the reversible preservation of biological samples are provided. The compositions include *Acacia* Gum, including derivations and modifications thereof which are useful as a reversible preservation solution. A method is provided for using *Acacia* Gum to isolate and reversibly preserve a biological specimen in a dormant state at room temperature for an extended period with minimal damage to the specimen. The compositions and methods disclosed may also be used to create reversibly preserved biological specimens and biological receptors for use in biosensors.

10 Claims, 4 Drawing Sheets

U.S. PATENT DOCUMENTS

6,043,067	A	3/2000	Lihme et al.
6,130,034	A	10/2000	Aitken
6,140,121	A	10/2000	Ellington et al.
6,309,815	B1	10/2001	Tash et al.
6,391,296	B1	5/2002	Okano et al.
6,413,713	B1	7/2002	Serebrennikov
6,420,171	B1	7/2002	Nakamura et al.
6,472,160	B2	10/2002	Saruta et al.
6,593,309	B2	7/2003	Ellington et al.
6,596,310	B1	7/2003	Chou et al.
6,649,384	B2	11/2003	Walsh et al.
6,828,090	B2	12/2004	Lucas et al.
2003/0091971	A1	5/2003	Xia et al.
2003/0100103	A1	5/2003	Saruta et al.
2003/0104506	A1	6/2003	Durst et al.

FOREIGN PATENT DOCUMENTS

DE	3733551	C2	4/1989
EP	0 699 905	A	3/1996
FR	2 732 240		3/1995
GB	865239	A	4/1961
GB	2 093 040	A	8/1982
WO	WO 00/51573		9/2000

OTHER PUBLICATIONS

Mallick et al.2000. An experimental investigation of electrical conductivities in biopolymers. 2000. Bull. Mater. Sci., vol. 23, No. 4, pp. 319-324.*

Yokohama, et al., "Deep Freezing of Horse Erythrocytes Cryo-protective Agents and Properties of the Cells Frozen Stored for 4 Years," Japanese Journal of Zootechnical Science; 1981; Abstract; pp. 487-492, vol. 52, No. 7.

Munderloh, et al., "Isolation of the Equine Granulocytic Ehrlichiosis Agent, *Ehrlichia Equi*, in Tick Cell Culture," Journal of Clinical Microbiology; 1996; Abstract; pp. 664-670, vol. 34, No. 3.

Tilak R. Bhardwaj, et al. "Natural Gums and Modified Natural Gums as Sustained-Release Carriers" Drug Development and Industrial Pharmacy, 26(10), 2000: pp. 1025-1038.

D.J. Burgess et al., "Spontaneous Formation of Small Sized Albumin/acacia Coacervate Particles," J. Pharm. Pharmacol. (1993) 45:586-591.

S.K. Baveja et al. "Examination of Natural Gums and Mucilages as Sustaining Materials in Tablets Dosage Forms," Indian J. Pharm Sci., (1988) 50(2): pp. 89-92.

D. Verbeken et al. "Exudate Gums: Occurrence, Production, and Applications" Appl. Microbiol Biotechnol (2003) 63:10-21.

Maria de Carmen de la Rosa et al. "Microbiological Quality of Pharmaceutical Raw Materials," Pharmaceutica Acta Helvetiae 70 (1995) 227-232.

Hiroaki Jizomoto et al. "Gelatin-Acacia Microcapsules for Trapping Micro Oil Droplets Containing Lipophilic Drugs and Ready Disintegration in the Gastrointestinal Tract," vol. 10, No. 8, 1993.

Biosensor—Wikipedia, the free encyclopedia, available on-line at <http://en.wikipedia.org/wiki/Biosensor>, at least as of Oct. 24, 2007.
Cranfield Biotechnology Centre—Biosensors: Past, Present and Future, available on-line at <http://www.legacy.cranfield.ac.uk/biotech/chinap.htm>, at least as of Oct. 25, 2007.

* cited by examiner

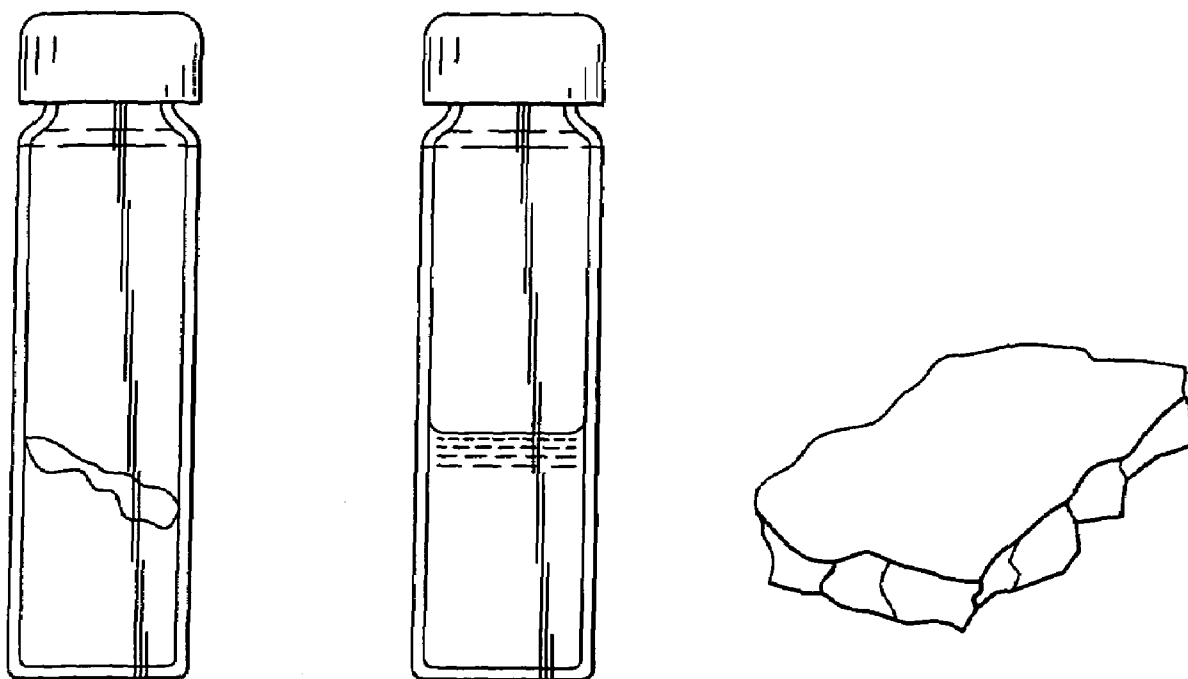

FIG 1

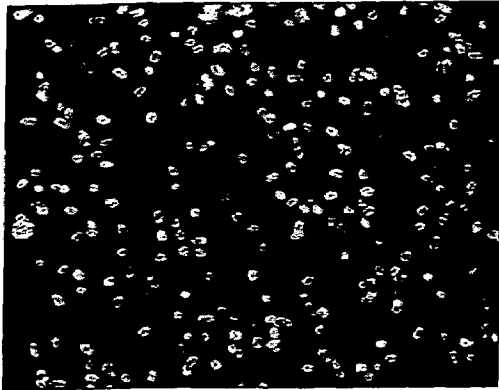

FIG 2A

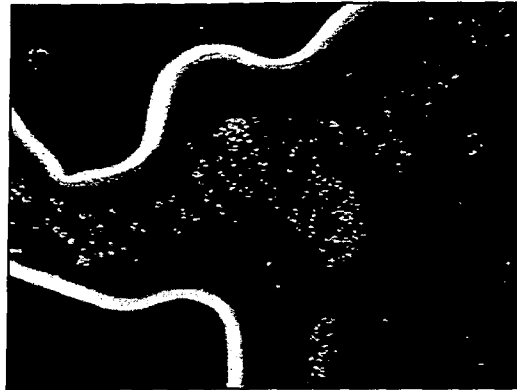

FIG 2B

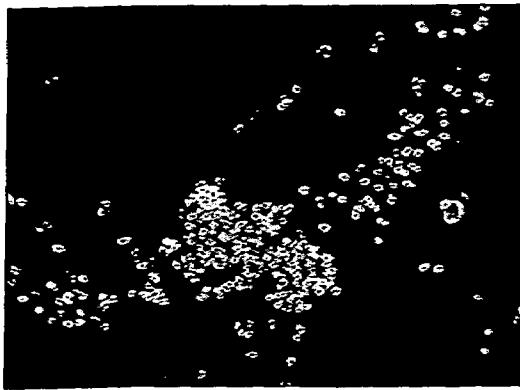

FIG 2C

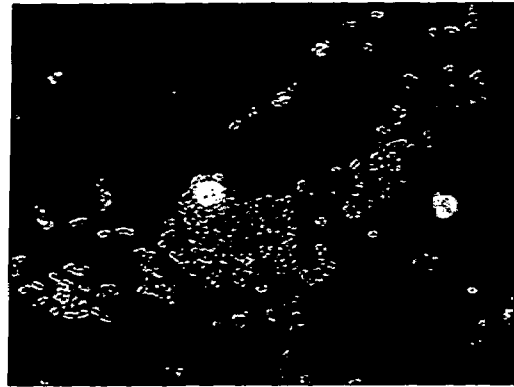

FIG 2D

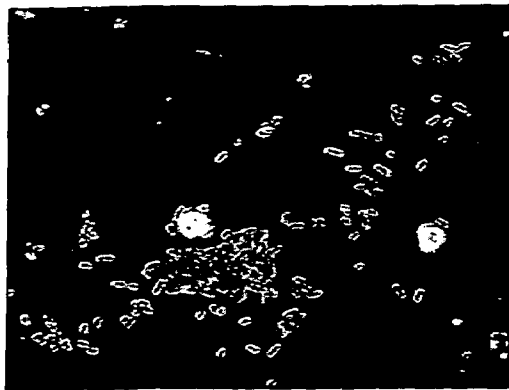

FIG 2E

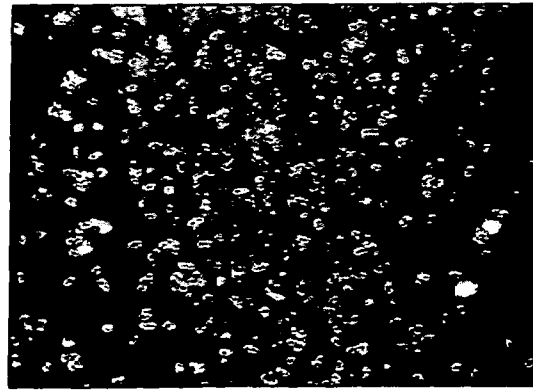

FIG 2F

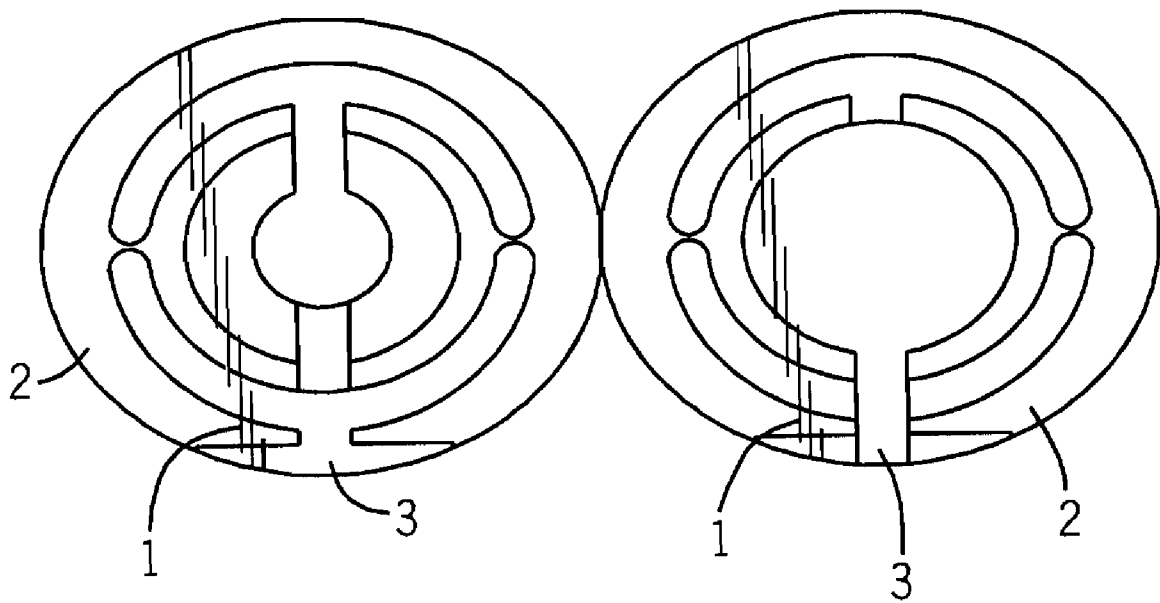

FIG. 3

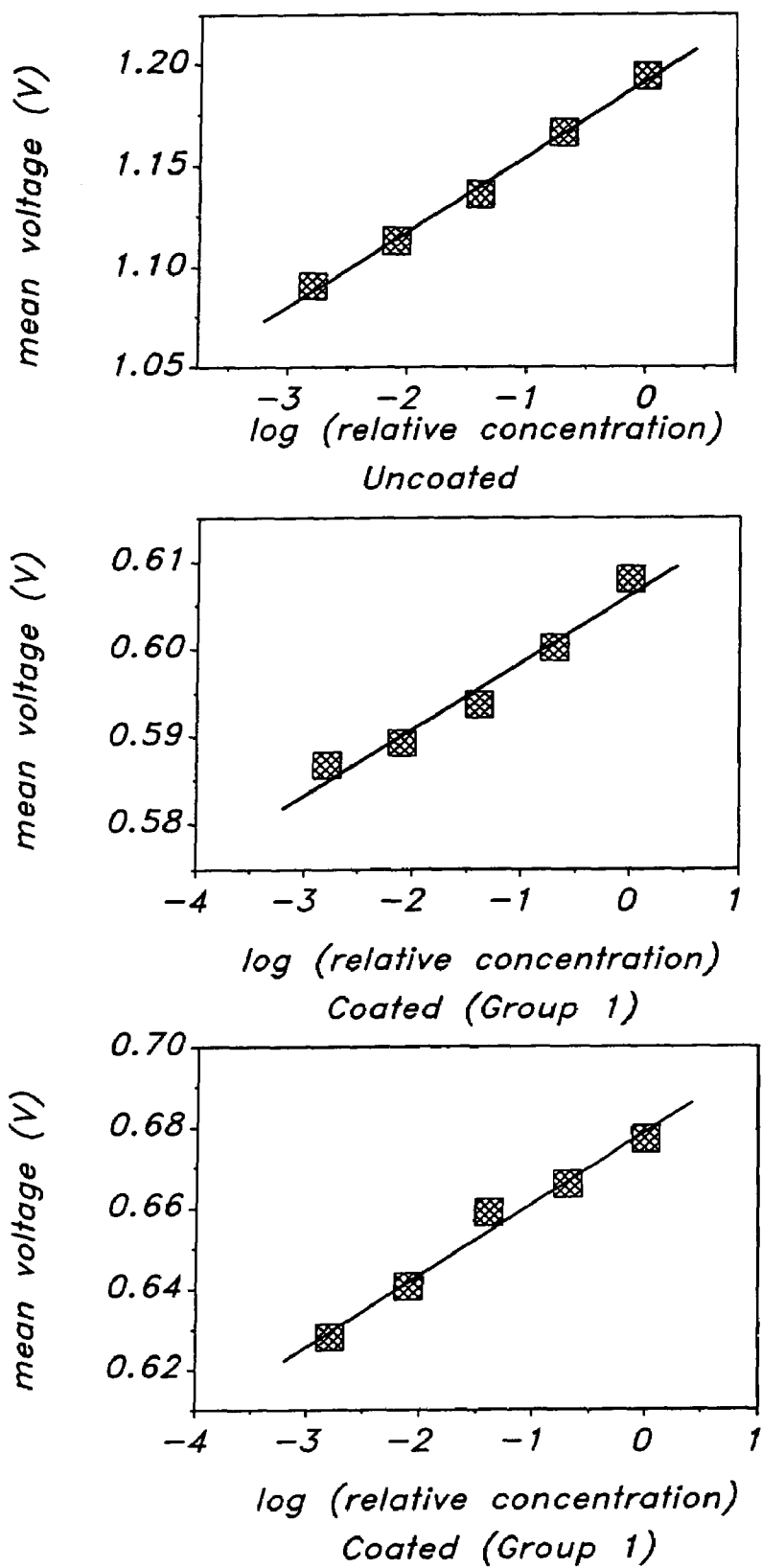

FIG 4

1

USE OF ACACIA GUM TO ISOLATE AND PRESERVE A BIOLOGICAL RECEPTOR ON A BIOSENSOR

CROSS-REFERENCE TO RELATED APPLICATIONS

This application is a divisional of U.S. application Ser. No. 10/000,727, filed on Nov. 30, 2001 now issued as U.S. Patent No. 7,022,514 on Apr. 4, 2006, which is incorporated herein in its entirety by reference, and which claims the benefit and priority of U.S. Provisional Application No. 60/250,798, filed Dec. 1, 2000, entitled "Method of Protection of Biosensor Surface," and U.S. Provisional Application No. 60/250,799, filed Dec. 1, 2000, entitled "Method for Protection of Biological Material," both of which are also incorporated herein in their entirety by reference.

TECHNICAL FIELD

The present invention relates generally to the field of biological sample preservation and, more particularly, to a method of using a solution of *Acacia* gum to preserve a biological specimen in a dormant state and, later, using an aqueous solution to restore the specimen unharmed to its isolated condition.

BACKGROUND OF THE INVENTION

Various methods for the preservation of biological specimens have evolved over the years. Modern specimen preparation techniques for microbiology and electron microscopy typically include dehydration and immobilization, both of which are irreversible and often damage the integrity of the specimen.

Dehydration using chemicals or freezing temperatures typically causes structural damage to biological tissues. Chemicals may destroy the overall quality of the specimen, including the particular characteristics of interest to the scientist. Rapid freeze-drying often produces crystalline structures that are destructive to most biological tissues. The result of dehydration is a biological sample that has been significantly altered, beyond repair, from its natural state.

Immobilization of a biological sample within a polymer typically involves curing, using elevated temperatures or ultraviolet radiation, both of which are detrimental to specimen quality. The polymers and resins typically used for sample preparation today form a hard plastic when cured. Once a sample has been cured, the biological material cannot be restored to its isolated state.

Biological specimen preservation techniques are of particular concern in the preparation of biosensors. Biosensors are used in the health and environmental sciences for rapid detection of specific substances. Biosensors are currently used to detect the presence of pesticides, herbicides, and other compounds; to detect the presence of organic compounds such as alcohols, ammonia, and metals; and, to detect the presence of specific bacteria including algae, fungi, and pathogenic organisms such as *Escherichia coli* (*E. coli*) and *Salmonella*. Potential applications for biosensors include sensing pollution and microbial contamination of air and water, clinical diagnosis of medical conditions, fermentation analysis and control, monitoring and analysis of industrial gases and liquids, monitoring of mining conditions and sensing toxic gases.

Biosensors often have a very short shelf life because the antibody or other biological receptor degrades rapidly when

2

exposed to the environment. Like other biological samples, biological receptors need isolation and protection from the environment until ready for use. In field applications, especially, a variety of biological receptors may be needed at any time, depending upon the conditions.

There is an unsatisfied need in the art for biological samples that can be protected and preserved without altering or destroying the biological tissue. The demand for safe transport and prolonged storage of biological samples today requires preservation techniques that maintain the integrity and quality of the biological sample. Sensitive biological receptors used in biosensors need to be isolated from the environment, without damaging the receptor, until ready for use. None of the specimen preparation techniques in the art currently meet these needs.

There is also a need in the art for biological samples that can be restored to their isolated or prepared state after immobilization, with minimal damage, for later study or use. The current techniques of dehydration and immobilization are irreversible and destroy sample viability. Restoration is particularly critical for the biological receptors in biosensors, which are especially sensitive. There is a need, therefore, for a preservation technique that is both harmless and reversible.

SUMMARY OF THE INVENTION

The above and other needs are met by the present invention which, stated generally, provides a method of using *Acacia* gum to isolate and preserve biological material without damage to the specimen. The present invention further provides reversible techniques for using *Acacia* gum that maintain the integrity and viability of biological specimens, even after prolonged storage at room temperature.

In one aspect of the invention, a reversibly preserved biological specimen is provided. The specimen in an isolated condition has been combined with an effective amount of a solution of solid *Acacia* gum dissolved in water. The suspension has been cured in ambient conditions to form a solid that can later be restored to a suspension. In one aspect, the suspension is capable of being separated so that the biological specimen can be restored to its former, isolated condition. In one embodiment, the biological specimen may include a separate container holding an effective amount of aqueous solution to restore the suspension by irrigating the solid in ambient conditions with the aqueous solution. The aqueous solution used to irrigate the solid may include distilled water, a buffer of 3-(N-morpholino) propanesulfonic acid, and one or more salts such as potassium chloride, sodium chloride, magnesium chloride, and/or calcium chloride.

In another aspect of the invention, a method of reversibly preserving a biological specimen includes the steps of combining the specimen in an isolated condition with an effective amount of an *Acacia* gum solution to form a suspension and, then, curing the suspension in ambient conditions to form a solid. The preservation method may also include the steps of irrigating the solid in ambient conditions with an effective amount of an aqueous solution to restore the suspension and then separating the solution from the specimen to restore the specimen to its former, isolated condition.

In one embodiment, the *Acacia* gum solution is formed by dissolving solid *Acacia* gum in distilled water. The combining step may include immersing the specimen in the *Acacia* gum solution. The curing step may include stirring the suspension.

In one embodiment, the aqueous solution used to irrigate the solid may include distilled water, a buffer, and one or more salts such as potassium chloride, sodium chloride, magne-

sium chloride, and/or calcium chloride. The buffer may be 3-(N-morpholino) propanesulfonic acid.

The biological specimens suitable for preservation may be microorganisms, viruses, bacteria, phages, antibodies, antigens, DNA, RNA, receptors, enzymes, proteins, biochemicals, yeast, fungi, plant and animal cells and extracts, semen, sperm, ova, blood, tissue samples, cell samples, urine, saliva, lymphatic fluid, skin, hair, bones, or bone marrow. In one embodiment, the biological specimen may be a biosensor.

In another aspect of the invention, a method of fabricating a reversibly preserved biological specimen includes the steps of combining the biological specimen in an isolated condition with an effective amount of an *Acacia Gum* solution to form a suspension and, then, curing the suspension in ambient conditions to form a solid that can later be restored to a suspension. In one aspect, the suspension is capable of being separated so that the biological specimen can be restored to its former, isolated condition.

In one embodiment, the *Acacia gum* solution used in this method of fabrication is formed by dissolving solid *Acacia gum* in distilled water. The curing step may include stirring the suspension. The combining step may include immersing the specimen.

In one embodiment, the method may include providing an effective amount of aqueous solution to restore the suspension by irrigating the solid in ambient conditions with the aqueous solution. The aqueous solution used to irrigate the solid may include distilled water, a buffer of 3-(N-morpholino) propanesulfonic acid, and one or more salts such as potassium chloride, sodium chloride, magnesium chloride, and/or calcium chloride.

In another aspect of the invention, a method of restoring the biological receptor includes the steps of irrigating the solid in ambient conditions with an effective amount of an aqueous solution to restore the suspension and, then, separating the solution from the biological receptor such that the biological receptor is substantially restored to its former, isolated condition. In one embodiment, the aqueous solution used to irrigate the solid may include distilled water, a buffer, and one or more salts such as potassium chloride, sodium chloride, magnesium chloride, and/or calcium chloride. The buffer may be 3-(N-morpholino) propanesulfonic acid.

In another aspect of the invention, a biosensor having a reversibly preserved biological receptor includes a signal transducer, an interface connected to the signal transducer, and a solid containing the biological receptor. The solid has been formed by curing a suspension in ambient conditions. The suspension includes the biological receptor in its prepared condition and an effective amount of an *Acacia gum* solution. The suspension is capable of being separated so that the biological receptor can be restored to its former, prepared condition.

In one embodiment, the *Acacia gum* solution is formed by dissolving solid *Acacia gum* in distilled water. The biological receptors suitable for preservation may be microorganisms, viruses, bacteria, phages, antibodies, antigens, DNA, RNA, receptors, enzymes, proteins, biochemicals, yeast, fungi, plant and animal cells and extracts, semen, sperm, ova, blood, tissue samples, cell samples, urine, saliva, lymphatic fluid, skin, hair, bones, or bone marrow.

In one embodiment, the biosensor may include a separate container holding an effective amount of aqueous solution to restore the suspension by irrigating the solid in ambient conditions with the aqueous solution. The aqueous solution used to irrigate the solid may include distilled water, a buffer of 3-(N-morpholino) propanesulfonic acid, and one or more

salts such as potassium chloride, sodium chloride, magnesium chloride, and/or calcium chloride.

In another aspect of the present invention, a method of reversibly preserving a biological receptor includes the steps of combining the receptor in its prepared condition with an effective amount of an *Acacia gum* solution to form a suspension and, then, curing the suspension in ambient conditions to form a solid. The preservation method may also include the steps of irrigating the solid in ambient conditions with an effective amount of an aqueous solution to restore the suspension and then separating the solution from the receptor to restore the receptor to its former, prepared condition.

In one embodiment, the *Acacia gum* solution is formed by dissolving solid *Acacia gum* in distilled water. The curing step may include stirring the suspension.

In one embodiment, the aqueous solution used to irrigate the solid may include distilled water, a buffer, and one or more salts such as potassium chloride, sodium chloride, magnesium chloride, and/or calcium chloride. The buffer may be 3-(N-morpholino) propanesulfonic acid.

In another aspect of the invention, a method of fabricating a reversibly preserved biological receptor disposed upon the interface of a biosensor includes the steps of combining the biological receptor in its prepared condition with an effective amount of an *Acacia gum* solution to form a suspension and, then, curing the suspension in ambient conditions to form a solid that can later be restored to a suspension. In one aspect, the suspension is capable of being separated so that the biological receptor can be restored to its former, prepared condition. In one embodiment, the *Acacia gum* solution used in this method of fabrication is formed by dissolving solid *Acacia gum* in distilled water. The curing step may include stirring the suspension. The combining step may include immersing the receptor.

In one embodiment, the method may include providing an effective amount of aqueous solution to restore the suspension by irrigating the solid in ambient conditions with the aqueous solution. The aqueous solution used to irrigate the solid may include distilled water, a buffer of 3-(N-morpholino) propanesulfonic acid, and one or more salts such as potassium chloride, sodium chloride, magnesium chloride, and/or calcium chloride.

In another aspect of the invention, a method of restoring the biological receptor includes the steps of irrigating the solid in ambient conditions with an effective amount of an aqueous solution to restore the suspension and, then, separating the solution from the biological receptor such that the biological receptor is substantially restored to its former, prepared condition. In one embodiment, the aqueous solution used to irrigate the solid may include distilled water, a buffer, and one or more salts such as potassium chloride, sodium chloride, magnesium chloride, and/or calcium chloride. The buffer may be 3-(N-morpholino) propanesulfonic acid.

In another aspect of the invention, a water-soluble solid for reversibly preserving a biological specimen includes a suspension formed by combining the biological specimen in an isolated condition and an effective amount of a solution of solid *Acacia gum* dissolved in water and an effective amount of aqueous solution to restore the suspension by irrigating the solid in ambient conditions with the aqueous solution.

In one embodiment, the aqueous solution used to irrigate the solid may include distilled water, a buffer, and one or more salts such as potassium chloride, sodium chloride, magnesium chloride, and/or calcium chloride. The buffer may be 3-(N-morpholino) propanesulfonic acid.

Thus, it is an object of the present invention to provide compositions and methods for protecting and preserving bio-

logical samples without altering or destroying the biological tissue. It is a related object to provide preservation techniques that maintain the integrity and quality of the biological sample.

It is a further object of the present invention to provide biological samples that can be restored to their isolated or prepared state after immobilization, with minimal damage, for later study or use. It is a related object of the present invention to provide a preservation technique that is both harmless and reversible.

It is a further object of the present invention to provide methods for restoring biological specimens and receptors to their former conditions without a significant loss in viability or function.

It is another object of the present invention to provide biosensors with biological receptors that can be restored to their prepared state after immobilization, with minimal damage, for later study or use.

It is yet another object of the present invention to provide a water-soluble solid for preserving biological specimens such that the specimens can later be restored to their isolated state with minimal damage.

These and other objects are accomplished by the method disclosed and will become apparent from the following detailed description of one preferred embodiment in conjunction with the accompanying drawings.

BRIEF DESCRIPTION OF THE DRAWING

FIG. 1 includes line drawings showing *Acacia gum* powder in the vial on the left, *Acacia gum* in aqueous solution in the other vial, and a solid sheet of *Acacia gum* at room temperature.

FIG. 2 FIG. 2 is a series of photographs of *Salmonella* bacteria at various stages of immobilization and restoration, according to an embodiment of the present invention. Slide 2A shows the bacteria immersed in the *Acacia gum* solution. Slide 2B shows the bacteria immobilized within the *Acacia gum* solution, which has become a solid at room temperature. The restoration process is shown in Slides 2C (one minute), 2D (two minutes), 2E (three minutes), and 2F (ten minutes).

FIG. 3 includes line drawings of crystal biosensors coated with a film of *Acacia gum* solution, according to an embodiment of the present invention. As shown in FIG. 3, a biosensor is comprised of a biological receptor, an interface, and a signal transducer. In FIG. 3, the biological receptor is deposited in a film 1 onto a piezoelectric crystal 2, which serves as the interface. An electrode 3 attached to the crystal acts as the signal transducer.

FIG. 4 is a series of graphs representing the results of experimentation conducted according to an embodiment of the present invention.

DETAILED DESCRIPTION

The present invention, generally described, provides compositions and methods for the preservation of biological samples. The compositions comprise *Acacia gum*, including derivations and modifications thereof which are useful as a reversible preservation solution. *Acacia gum* is a complex and highly branched carbohydrate polymer. The central core or nucleus is D-galactose and D-glucuronic acid, to which are attached sugars such as L-arabinose, L-rhamnose, and the like. *Acacia gum* is available as thin flakes, powder, granules, or angular fragments which are completely soluble in hot and cold water.

Acacia gum is a natural exudate or sap obtained from any of several plants belonging to the genus *Acacia*. *Acacia senegal* and *Acacia seyal* trees are the most commercially exploited species. *Acacia gum* typically refers to the gum harvested from *Acacia senegal* trees. *Acacia* plants are leguminous shrubs and trees that grow in warm regions, such as the Republic of the Sudan and the Upper Nile region of eastern Africa, where most of the world's *Acacia gum* is harvested.

Acacia gum was widely used in ancient Egypt in the preparation of inks and dyes and is thought to have been used as an adhesive for mummification bindings. An article of commerce for centuries, the name "Arabic Gum" is believed to have been derived from the fact that *Acacia gum* was typically shipped from Arabian ports to Europe. Today, *Acacia gum* is used in the manufacture of printing inks, textile dyes, adhesives, pharmaceuticals, vitamins, confections, foods, beverages, cosmetics, and many other products. For example, *Acacia gum* is used to make the water-soluble glue on postage stamps and envelopes, added to candies to prevent crystallization, used as a coating to flavor particles and beverages, added to beer to stabilize the foam, used as an emulsifier of fats in foods, lotions, and soaps, and is the most important gum in the manufacture of ink.

The botanical name for the *Acacia gum* referred to in this application is *Acacia nilotica* (Linn.), N.O. *Leguminosae*. *Acacia gum* is water-soluble, edible, non-toxic, highly uniform, pale in color, and has excellent emulsifying and film-forming qualities. *Acacia gum* consists mainly of high-molecular weight polysaccharides and their calcium, magnesium and potassium salts.

Acacia gum is harvested by tapping the trunk of an *Acacia senegal* tree, which causes the gum to seep out and solidify into colorless or pale yellow tear-shaped nodules. The dried nodules are typically gathered by hand. *Acacia gum* is commercially available in the form of white or yellowish flakes, granules, or powder. *Acacia Gum* powder is plentiful and readily available commercially, at a low cost. When the powder form is dissolved in water, the resulting solution becomes increasingly viscous as the water evaporates, becoming a solid at room temperature. The photograph in FIG. 1 shows *Acacia gum* powder in the vial on the left, *Acacia gum* in aqueous solution in the other vial, and between the vials a solid sheet of *Acacia gum* at room temperature.

The compositions of the invention are useful for the preservation of any biological sample of interest. Such samples include, without limitation, microorganisms, viruses, bacteria (such as *E. coli*, *Salmonella*, *Listeria*, *Staphylococcus*, and others), phages, antibodies, antigens, DNA, RNA, receptors, enzymes, proteins, biochemicals, yeast and other fungi, and plant and animal cells and extracts. Animal cells and extracts include, without limitation, semen, sperm, ova, blood, tissue samples, cell samples, urine, saliva, lymphatic fluid, skin, hair, bones, and bone marrow. Additionally, biological samples include proteins, enzymes, antibodies, monoclonal antibodies and the like.

The phrase, "biological specimen in an isolated condition," as used herein indicates a biological sample that has been isolated and substantially purified; meaning that it is substantially or essentially free from components that normally accompany or interact with the sample as found in its natural environment.

Isolation and Preservation Technique

Acacia gum powder is readily soluble in water. The solution becomes increasingly viscous as some of the water

evaporates. An aqueous *Acacia gum* solution is characterized by its reversibility. If more water is added, the viscosity decreases. Even if the solution is permitted to harden or cure into a solid, the addition of water will return the solid to an aqueous solution. Reversibility in this context also refers to the fact that the *Acacia gum* solution can be separated nearly completely from the biological specimen after the preservation method of the present invention has been performed.

In one embodiment of the present invention, a biological specimen is preserved by being immersed in or otherwise combined with an effective amount of *Acacia gum* or an *Acacia gum* solution. The amount of *Acacia gum* solution will vary depending upon sample size. The phrase "effective amount" is intended to indicate an amount sufficient to form a suspension; that is, to suspend the biological molecules or

initially upon being immersed in the solution, biological material such as bacteria remain active and motile. As the viscosity increases, activity and motility decrease. In one embodiment, the suspension may be stirred to ensure a good distribution of specimen or to speed the evaporation of water and thus accelerate the curing process. Curing may take place in ambient conditions; in other words, at room temperature and at normal atmospheric pressures. When the solution solidifies, the bacteria shrink to about one-half to one-third of their original size. While the invention is not bound by any particular mechanism of action, it is postulated that the *Acacia gum* solution penetrates the cell membrane of the biological material, possibly replacing the water and resulting in the overall shrinkage observed. Inside the resulting solid, the bacteria remain dormant and may be kept at room temperature.

In one embodiment, the solid material containing the biological specimen may be made into a powder, pellets, tablets, flakes, plates, capsules, or other forms or containers. The solid is transparent to visible light, a feature that makes it suitable for viewing and for certain optical applications. Moreover, although the solid is water-soluble, the solid is resistant to almost all organic solvents and most acids.

To restore the biological material to its isolated condition, the solid is irrigated with an aqueous solution. The amount of aqueous solution needed to change the solid back into a suspension will vary depending upon the sample size. The phrase "effective amount of aqueous solution" is intended to indicate an amount sufficient to transform the solid into a suspension.

In one aspect of the invention, the aqueous solution used to irrigate the solid contains distilled water, a buffer, and one or more salt compounds such as potassium chloride, sodium chloride, magnesium chloride, and calcium chloride. The buffer is a substance capable in solution of neutralizing both acids and bases and, thereby, maintaining the original pH of the solution. One such pH buffer in common use is 3-(N-morpholino) propanesulfonic acid (also known as MOPS). Another common pH buffer is called a phosphate buffer. A phosphate buffer, in one form, contains anhydrous monosodium phosphate and trisodium phosphate dodecahydrate. A phosphate buffer solution may contain different molar ratios of monosodium phosphate and trisodium phosphate, depending upon the value of the pH to be maintained.

When irrigated, the solid gradually dissolves and the biological specimen is again suspended within an *Acacia gum* solution. The viscosity of the suspension decreases as more aqueous solution is added. The biological specimen returns to its normal size, absorbing the water lost or exchanged during the curing process.

In another aspect of the present invention, the suspension of biological material and *Acacia gum* solution is reversible because it can be separated. The *Acacia gum* solution can be removed using common methods of separating mixtures, leaving the biological specimen in its isolated condition. The separation step restores the biological specimen to its former isolated or prepared condition. The phrase "substantially restored" is intended to describe the nearly complete separation of the *Acacia gum* solution from the biological specimen and the nearly complete restoration of viability of the biological specimen.

Biosensors

The methods of the invention find particular use in preserving biological samples on biosensors. A biosensor, as shown in FIG. 3, is comprised of a biological receptor, an interface, and a signal transducer. The biochemical signal produced when a sample is placed on the biological receptor is converted or translated by the signal transducer into a quantifiable electrical signal.

The biological receptor is selected to sense a specific target compound called the analyte. For example, a copper receptor will absorb copper molecules from a sample. The signal transducer converts the activity on the receptor (e.g., the accumulation of copper molecules) into an electrical signal. For example, the signal transducer can detect the increased mass of the biosensor by sensing changes in certain electrical properties.

The types of biological receptors in use include, without limitation, enzymes, antibodies, phages, and lipid layers. The biological receptor must be prepared such that it will respond to the analyte. Preparation of the biological receptor includes depositing the biological material onto the interface. Preparation of the interface to receive the biological receptor may include chemical etching of the interface, the application of thin membranes, coating the interface with a thin layer of a particular biochemical to serve as an anchor for the biological receptor, or any other of a variety of preparation methods. The phrase, "biological specimen in a prepared condition," as used herein indicates a biological receptor that has been isolated and deposited upon the biosensor interface using any preparation technique that renders the receptor ready for its intended use.

The signal transducer is typically an electrode connected to the interface to measure any change in the receptor when the sample is introduced. Signal transducer systems include, without limitation, piezoelectric crystals, conductimeters, enzyme-sensing electrodes, thermistors, optoelectronic and fiber-optic devices, field-effect transistors, gas-sensing electrodes, and ion-selective electrodes. The signal transducer itself may be a pH-electrode, an oxygen electrode, or a piezoelectric crystal.

In a common biosensor using quartz crystal technology, shown in FIG. 3, the biological receptor is deposited in a film onto a piezoelectric crystal, which serves as the interface. An electrode attached to the crystal acts as the signal transducer. The quartz crystal is oscillated at a known frequency based on its total mass, including the mass of the film receptor. When a sample containing the analyte is placed on the receptor, the total mass will change when the antibodies in the receptor bind to the analyte. In response to the change in mass, the frequency of the crystal oscillation will change, and the change in frequency is measured by the signal transducer. Because frequency and mass are related, the additional mass can be calculated, indicating the precise amount of the analyte present in the sample.

The Biosensor Experiment

A biosensor with a biological receptor comprised of antibodies against *Salmonella* bacteria was covered with a film of *Acacia gum* solution. After curing and storage at room temperature for a period of four (4) days, the antibodies were released by irrigation with water containing 55.0 milli-Molar potassium chloride, 4.0 milli-Molar sodium chloride, 1.0 milli-Molar magnesium chloride, 0.1 milli-Molar calcium chloride, and 2.0 milli-Molar 3-(N-morpholino) propane-sulfonic acid, used as a pH buffer. Preliminary data was obtained demonstrating the sensitivity of the restored sensors compared to the uncoated sensors, as shown in FIG. 4 and Table One.

TABLE ONE

Performance of Coated <i>Salmonella</i> Biosensors.			
	Uncoated	Coated (Group 1)	Coated (Group 2)
Total Sensors	9	4	22
Good Sensors	4	1	8
Yield (%)	44.4%	25.0%	36.4%
Slope (mV per decade)	15.3	7.6	19.4

Measurements were carried out with a Quartz Crystal Microbalance (QCM) measurement system. More specifically, the biosensors used in this experiment were the PM-700 series quartz sensor crystals available from Maxtek, Inc. The output of the sensor crystal corresponds to the change in total mass. The signal transducer measures the change in the crystal in millivolts (mV). Referring to Table One and the graphs shown in FIG. 4, the "mV per decade" refers to the voltage change for each order of magnitude change in the bacterial concentration.

The bacterial suspension of approximately 10^9 cells per milliliter was diluted 10, 100, and 1000 times, respectively. The relative concentrations of bacteria were, therefore, 1, 10^{-1} , 10^{-2} , and 10^{-3} . Accordingly, the logarithms (shown in FIG. 4) of the relative concentrations were 0, -1, -2, and -3, respectively.

For purposes of this experiment, a "good sensor" has a sensitivity of more than 7.0 mV per decade. The observation that only 44.4 percent of the uncoated biosensors were "good sensors" indicates the inherent fragility of the biological receptors used in biosensors.

The slope of the graphs shown in FIG. 4 indicates the degree of sensitivity of the biosensor. The uncoated biosensors had a sensitivity of 15.3 mV per decade. While the sensitivity of Group 1 decreased to 7.6 mV, the sensitivity of the coated biosensors in Group 2 was observed to be 19.4 mV better than the sensitivity of the uncoated sensors. In both cases, the biosensors which had been coated with the *Acacia gum* solution were fully operational and ready to use.

The Bull Sperm Experiment

In another aspect, the methods of the invention are useful in preserving animal cells and extracts, such as sperm. In another experiment, the isolation and preservation technique of the present invention was used to temporarily and reversibly preserve bull sperm.

A sample of bull sperm was immobilized in *Acacia gum* solution, where it remained at room temperature for a period of four (4) days before being released by irrigation with water. Although reproduction was not tested, the bull sperm showed no difference in motility when compared to the initial sample.

The present invention may be used to preserve bull sperm for transport or storage, at room temperature, without significant damage to the sperm. The cryogenic preparation and storage of bull sperm is expensive and destructive because of crystalline structures formed during freezing. In contrast, the present invention does not introduce crystals or other destructive structures into the sample and it is much less expensive.

Bacterial Cultures

The methods of the present invention are also useful in preserving samples of bacteria. Two separate experiments were conducted to test the response and subsequent viability of bacteria suspended within an *Acacia gum* solution.

In a first experiment, separate samples of *Escherichia coli* 0157 (*E. coli*) bacteria and *Salmonella* bacteria were immobilized in *Acacia gum* solution, where each sample remained at room temperature for a period of seven (7) days. The bacteria were released by irrigation with water containing a phosphate buffer (pH 7.4) containing 2.7 milli-Molar potassium chloride and 137 milli-Molar sodium chloride. The released bacteria showed no difference in motility when compared to the initial culture. The bacteria reproduced normally.

FIG. 2 shows the *Salmonella* bacteria at different stages of the experiment. Slide a shows the bacteria immersed in the *Acacia gum* solution. Slide b shows the bacteria immobilized within the *Acacia gum* solution, which has become a solid at room temperature. Notice that the bacteria in Slide b are somewhat smaller.

After remaining immobilized for seven (7) days, the bacteria were irrigated with an aqueous solution. The restoration process is shown in Slides c, d, e, and f.

Slide c shows the condition of the bacteria after one minute. Some motion was observed after two minutes, shown in Slide d. Slide e shows the condition of the bacteria after three minutes. After ten minutes, as shown in Slide f, the bacteria have returned to their normal size, absorbing the water lost during the immobilization or curing process.

In a second experiment, two additional samples of *E. coli* and *Salmonella* bacteria were immobilized in *Acacia gum* solution for a period of twenty-one (21) days, with the same results. The bacteria showed no difference in motility when compared to the initial culture and the bacteria reproduced normally.

Other Uses

The present invention offers a method of reversibly preserving biological specimens in a variety of contexts. The isolation and preservation techniques of the present invention could be used, without limitation, for isolating microbial cultures for shipment, blood isolation and storage, time-release capsules for pharmaceuticals, biodegradable packaging, soluble prostheses and implants, surgery, and forensics.

The *Acacia gum* solution and the isolation and preservation techniques of the present invention represent a simple, rapid, and inexpensive alternative to many of the biological preservation techniques in use today. *Acacia gum* is organic, water-soluble, bio-compatible, biodegradable, and non-toxic. The preservation of biological specimens with *Acacia gum* is reversible and causes little or no damage to the specimen.

While this invention has been described in specific detail with reference to the disclosed embodiments, it will be understood that many variations and modifications may be effected without departing from the invention as described in the appended claims.

11

The invention claimed is:

1. A method of preparing a biosensor for an analyte, the biosensor comprising: a biological receptor for detecting the analyte; an interface; and an electrical signal transducer; the method comprising:

- (a) depositing the biological receptor on the interface, wherein the interface binds the biological receptor;
- (b) covering the biological receptor with a film of *Acacia* gum solution; and
- (c) curing the *Acacia* gum to form a solid disposed upon the interface, wherein the solid is dissolved by irrigating with an aqueous solution and the biological receptor remains bound to the interface.

2. The method of claim 1, wherein the *Acacia* gum solution is prepared by dissolving a quantity of solid *Acacia* gum in distilled water.

3. The method of claim 1, wherein the biological receptor is selected from the group consisting of microorganisms, enzymes, antibodies, phages, and proteins.

4. The method of claim 1, wherein the biological receptor comprises a microorganism.

5. The method of claim 1, wherein the biological receptor comprises an antibody that specifically binds the analyte.

12

6. The method of claim 1, wherein the interface comprises quartz crystal.

7. The method of claim 1, wherein the transducer comprises an electrode.

8. A method of preparing a biosensor for an analyte, the biosensor comprising: an antibody that specifically binds the analyte; an interface; and an electrical signal transducer; the method comprising:

- (a) depositing the antibody on the interface, wherein the interface binds the antibody;
- (b) covering the antibody with a film of *Acacia* gum solution; and
- (c) curing the *Acacia* gum to form a solid disposed upon the interface, wherein the solid is dissolved by irrigating with an aqueous solution and the antibody remains bound to the interface.

9. The method of claim 8, wherein the interface comprises quartz crystal.

10. The method of claim 8, wherein the transducer comprises an electrode.

* * * * *